

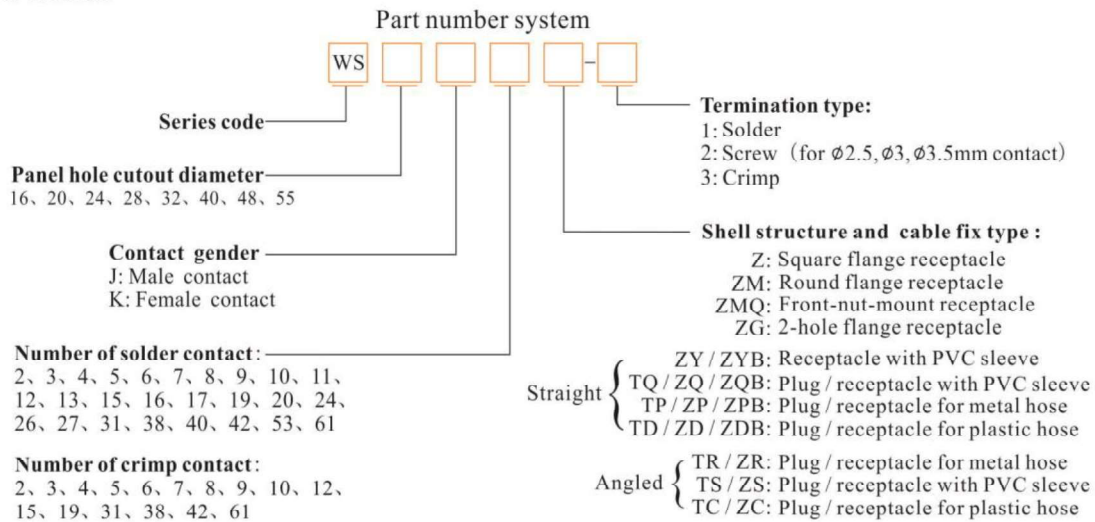

● **WS Series**



● **Remarks :** The rated current decreases according to the number of contacts, more contacts, less rated current.

Number of contact	1-3	4-10	11-20	21-30	31-40	41-50	51-61
Rated current decrease rate (%)	0	10	20	30	40	50	60

★ Each side can be male or female contact

★ Solder contact spec see page 87-88

★ Crimp contact spec see page 89-92

**Material and spec**

Coupling	Threaded
Shell material	Zinc alloy with chrome plating
Insert material	PPS, max temperature 260 °C
Contact material	Brass with gold plating
Termination	Solder: $\phi 1, 1.5, 2.5, 3.5, 5.5$ mm contact Screw: $\phi 2.5, 3, 3.5$ mm contact Crimp: $\phi 1, 1.5, 2.5, 3.5$ mm contact
Mating cycle	500
Temperature range	-40°C~+85°C

### WS Series Mating diagram

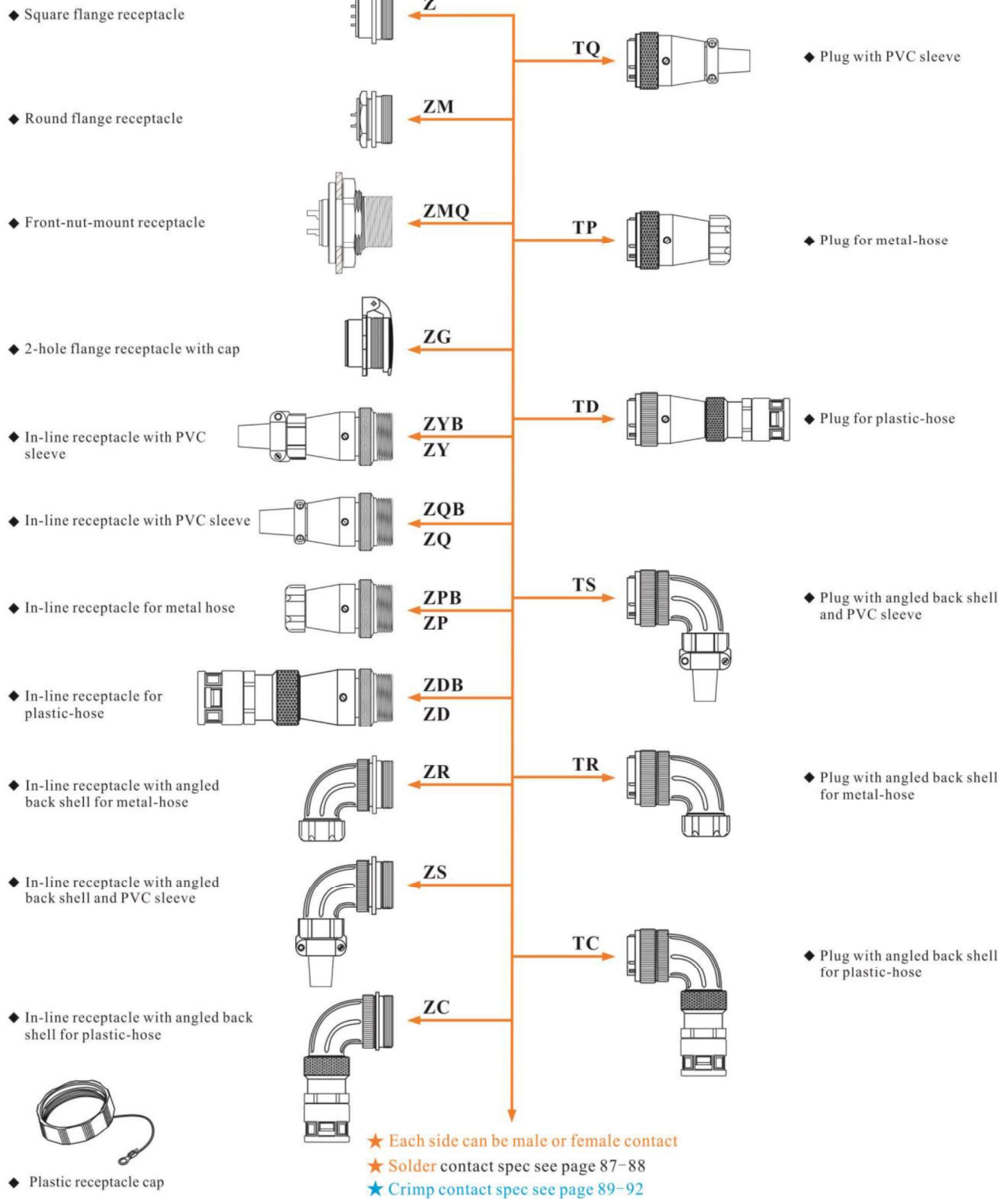



● Square flange receptacle: Z

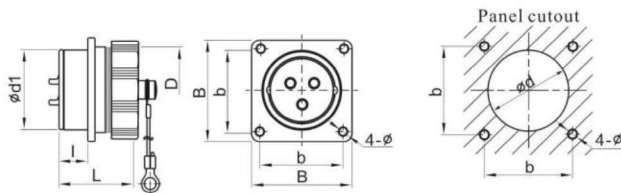

Dimension(mm)	WS16	WS20	WS24	WS28	WS32	WS40	WS48	WS55
∅d1	15.8	19.8	23.8	27.8	31.8	39.8	47.8	54.8
D	M18X1	M22X1	M26X1	M30X1	M35X1.5	M44X1.5	M52X1.5	M59X1.5
l	9.7	9.8	10	9.8	14.4	14.2	14.2	14
L	21.6	23	23	23	34	34	34	34
b	20	22	26	30	32	40	48	52
B	26	29	32	36	42	50	58	64
∅d	16.5	20.5	24.5	28.5	32.5	40.5	48.5	55.5
∅	3.2	3.2	3.2	3.2	3.5	4.5	4.5	4.5

● Round flange receptacle: ZM

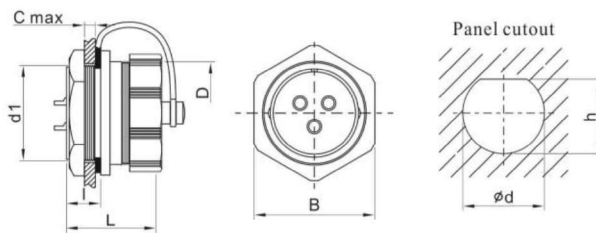

Dimension(mm)	WS16	WS20	WS24	WS28
d1	M16X1	M20X1	M24X1	M28X1
D	M18X1	M22X1	M26X1	M30X1
C	5	5	5	5
l	9.7	9.9	10	10.2
L	22	23	23	23
B	21.2	25.5	29.2	33.3
∅d	15.7	19.7	23.9	27.7
h	15.3	19.3	23.2	26.9



● Front-nut-mount receptacle: ZMQ IP67

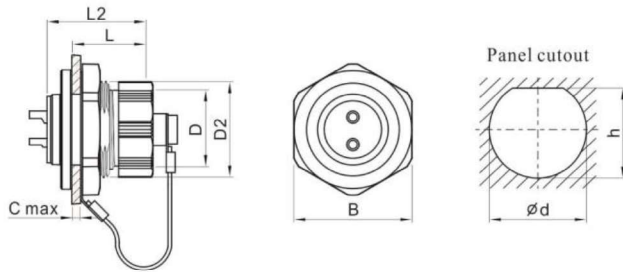

Dimension(mm)	WS16	WS20	WS24	WS28
øD	M18X1	M22X1	M26X1	M30X1
D2	M22X1	M26X1	M30X1	M34X1
L	16	17	17	17
L2	21.6	23	23	23
C	5	5	5	5
B	26.8	30.8	34.8	38.8
ød	22	26	30	34
h	20.6	24.6	28.6	32.6

● 2-hole flange receptacle with cap: ZG

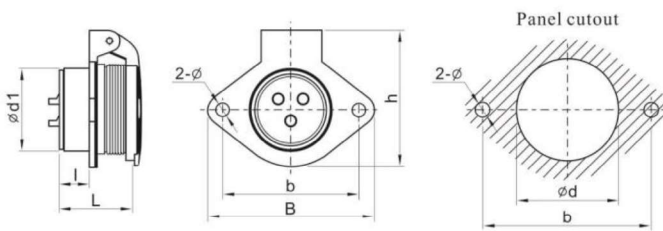

Dimension(mm)	WS16	WS20	WS24	WS28	WS32	WS40	WS48	WS55
ød1	15.8	19.8	23.8	27.8	31.8	39.8	47.8	54.8
l	10	10	10	10	15.4	14.7	14.3	14
L	22	23	23	23	34	34	34	34
b	30	35	40	45	55	65	80	85
B	38	44	50	55	67	77	92	98
h	32.5	36.5	40.5	45.5	52.5	63.5	74.5	80
ød	16.5	20.5	24.5	28.5	32.5	40.5	48.5	55.5
ø	3.5	4.5	4.5	4.5	5.5	5.5	5.5	6.5



● In-line receptacle with PVC sleeve B: ZQB

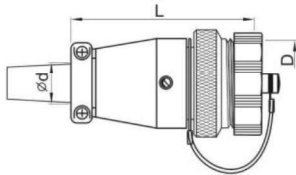

Dimension(mm)	WS16	WS20	WS24	WS28
D	M18X1	M22X1	M26X1	M30X1
L	44.3	48.3	53.5	56
ød max	10	11.6	12.4	15.7

● In-line receptacle with PVC sleeve: ZQ

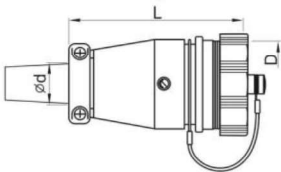

Dimension(mm)	WS32	WS40	WS48	WS55
D	M35X1.5	M44X1.5	M52X1.5	M59X1.5
L	70	77	85	97
ød max	19.5	24	24	30

● In-line receptacle for metal-hose B: ZPB

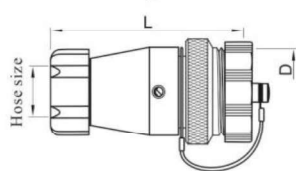

Dimension(mm)	WS16	WS20	WS24	WS28
D	M18X1	M22X1	M26X1	M30X1
L	49.5	58	62	65
Hose size	1/4"	3/8"	3/8"	1/2"

● In-line receptacle for metal-hose: ZP

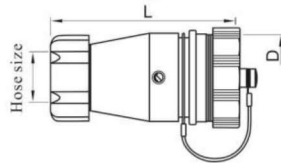

Dimension(mm)	WS32	WS40	WS48	WS55
D	M35X1.5	M44X1.5	M52X1.5	M59X1.5
L	75	99	103	106
Hose size	3/4"	1"	I: 1" II: 1 1/4"	1 1/4"

● In-line receptacle with cable clamping plates B: ZYB

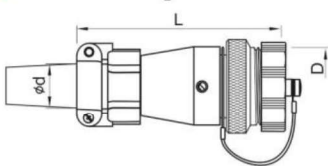

Dimension(mm)	WS16	WS20	WS24	WS28
D	M18X1	M22X1	M26X1	M30X1
L	48.5	54.5	55.5	65.3
ød max	10	13	13	17

● In-line receptacle with cable clamping plates: ZY

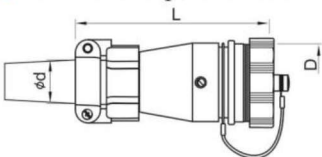

Dimension(mm)	WS32	WS40	WS48	WS55
D	M35X1.5	M44X1.5	M52X1.5	M59X1.5
L	89.2	94.8	101.8	124.7
ød max	19	23	I: 23 II: 31	31



● In-line receptacle for plastic-hose: ZDB

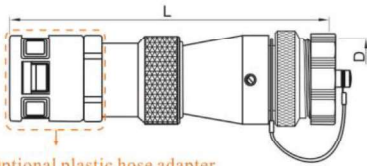

Optional plastic hose adapter

Dimension (mm)	WS16	WS20	WS24	WS28
D	M18X1	M22X1	M26X1	M30X1
L	80	90	97	104
Adapter size	PG7	PG11	PG11	PG16
Hose size	1/4"	3/8"	3/8"	1/2"

● In-line receptacle for plastic-hose: ZD

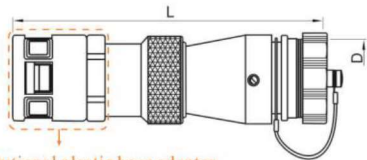

Optional plastic hose adapter

Dimension (mm)	WS32	WS40	WS48	WS55
D	M35X1.5	M44X1.5	M52X1.5	M59X1.5
L	126.7	134	141	160
Adapter size	PG21	PG29	I: PG29 II: PG36	PG36
Hose size	3/4"	1"	I: 1" II: 1 1/4"	1 1/4"

● In-line receptacle with angled back shell for metal-hose: ZR

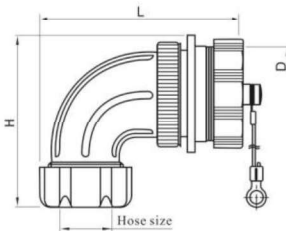

Dimension (mm)		WS20	WS24	WS28	WS32	WS40	WS48	WS55
D	—	M22X1	M26X1	M30X1	M35X1.5	M44X1.5	M52X1.5	M59X1.5
L	—	60	60	63	81	88	96	107
H	—	48	51	52	58	70	82	90
Hose size	—	3/8"	3/8"	1/2"	3/4"	1"	1"	1 1/4"

● In-line receptacle with angled back shell and PVC sleeve: ZS

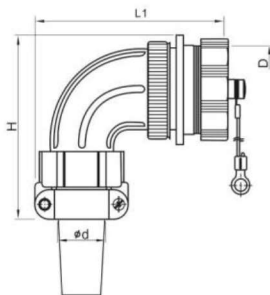

Dimension (mm)		WS20	WS24	WS28	WS32	WS40	WS48	WS55
D	—	M22X1	M26X1	M30X1	M35X1.5	M44X1.5	M52X1.5	M59X1.5
L	—	60.6	60.4	64.7	82	89.2	96	114.2
H	—	54.4	56.8	64	72	83.3	94.5	112.3
ød max	—	13	13	17	19	23	23	31



● In-line receptacle with angled back shell for plastic-hose: ZC

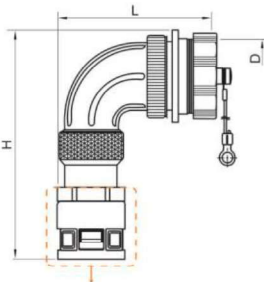

Optional plastic hose adapter

Dimension (mm)		WS20	WS24	WS28	WS32	WS40	WS48	WS55
D	—	M22X1	M26X1	M30X1	M35X1.5	M44X1.5	M52X1.5	M59X1.5
L	—	60	60	65	82	90	95	110
H	—	88	88	98	110	120	135	140
Adapter size	—	PG11	PG11	PG16	PG21	PG29	PG29	PG36
Hose size	—	3/8"	3/8"	1/2"	3/4"	1"	1"	1 1/4"

● Plug with PVC sleeve: TQ

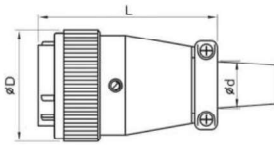

Dimension (mm)	WS16	WS20	WS24	WS28	WS32	WS40	WS48	WS55
∅D	21.8	26.4	29.8	34	39.3	49.3	57.2	64.5
L	44	49.5	53.5	56	70	75.5	85.5	97
∅d max	10	11.6	12.4	16	19.5	24	24	30

● Plug for metal-hose: TP

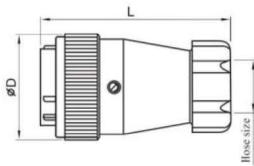

Dimension (mm)	WS16	WS20	WS24	WS28	WS32	WS40	WS48	WS55
∅D1	21.5	26.4	29.8	34	39.3	49.3	57.2	64.5
L	48	57	58	61	74	82	90	100
Hose size	1/4"	3/8"	3/8"	1/2"	3/4"	1"	I: 1" II: 1 1/4"	1 1/4"

● Plug for plastic-hose: TD

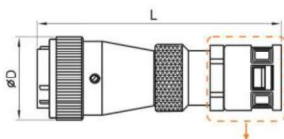

Optional plastic hose adapter

Dimension (mm)	WS16	WS20	WS24	WS28	WS32	WS40	WS48	WS55
∅D	21.5	26.4	29.8	34	39.3	49.3	57.2	64.5
L	63	75	60	63	120	132	138	150
Adapter size	PG7	PG11	PG11	PG16	PG21	PG29	I: PG29 II: PG36	PG36
Hose size	1/4"	3/8"	3/8"	1/2"	3/4"	1"	I: 1" II: 1 1/4"	1 1/4"



● Plug with angled back shell for metal-hose: TR

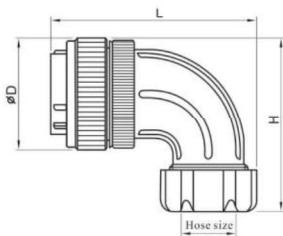

Dimension (mm)		WS20	WS24	WS28	WS32	WS40	WS48	WS55
øD	—	25.6	30	33.8	38.2	49.3	55.8	63
H	—	48	51	52	58	70	82	90
L	—	60	60	63	81	88	96	107
Hose size	—	3/8"	3/8"	1/2"	3/4"	1"	1"	1 1/4"

● Plug with angled back shell with PVC sleeve: TS

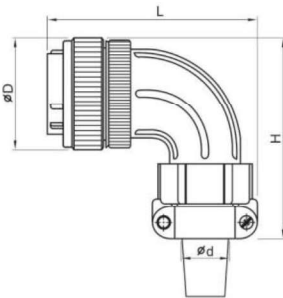

Dimension (mm)		WS20	WS24	WS28	WS32	WS40	WS48	WS55
øD	—	25.6	30	33.8	38.2	49.3	55.8	63
H	—	53	57	61	66	78	91	100
L	—	60	61	64	80	88	96	107
ød max	—	11.6	12.4	15.7	19.5	24	24	30

● Plug with right angle back shell for plastic-hose: TC

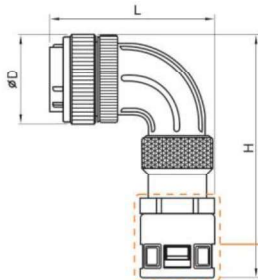

Dimension (mm)		WS20	WS24	WS28	WS32	WS40	WS48	WS55
øD	—	25.6	30	33.8	38.2	49.3	55.8	63
H	—	60	62	65	82	88	96	107
L	—	70	88	95	105	130	130	146
Adapter size	—	PG11	PG11	PG16	PG21	PG29	PG29	PG36
Hose size	—	3/8"	3/8"	1/2"	3/4"	1"	1"	1 1/4"

Optional plastic hose adapter